

LAVAMAT 62610

Washing machine

User information



Dear customer,

Please read this User Information carefully and keep it to refer to at a later date.

Pass this User Information on to any subsequent owner of the appliance.

The following symbols are used in the text:



Safety instructions

Warning: Notes that concern your personal safety.

Attention: Notes that show how to avoid damage to the appliance.



Useful tips and hints



Environmental information

Contents

Operating Instructions	5
Safety	5
Description of the appliance	7
Control panel	7
Programme overview	8
Before the first wash	10
Preparing and sorting washing	10
Running a washing cycle	11
Opening the door/Loading the washing	11
Adding detergent/additives	11
Switching on the appliance/selecting a programme	12
Changing the spin speed/Selecting rinse hold	13
Selecting the programme options	13
EXTRA RINSE	13
QUICK WASH	13
PREWASH.....	14
STAIN	14
Setting the delay timer	14
Starting a programme.....	14
Programme progress	15
Interrupting a programme/Adding washing	15
End of the wash cycle/Removing the washing	15
Child safety device	16
Cleaning and maintenance	17
What to do if...	18
Remedying small malfunctions	18
If the wash results are not satisfactory	20
Carrying out an emergency drain	21
Drain pump.....	22
Disposal	23
Technical data	24
Consumption values	24

Installation and connection instructions	25
Safety information for the installation	25
Installing the appliance	26
Transporting the appliance.....	26
Removing the transit packaging	26
Where to install	27
Making the appliance level.....	28
Electrical connection	29
Connecting to the water supply	29
Water inflow.....	30
Water drainage.....	31
Guarantee/Customer Service	32
Service	35

Operating Instructions



Safety

Prior to using for the first time

- Follow the **"Instructions for installation and connection"**.
- If the appliance is delivered in the winter months when there are minus temperatures: Store the washing machine at room temperature for 24 hours before using for the first time.

Correct use

- The washing machine is only designed for the washing of normal domestic laundry at home.
- Additions or modifications to the washing machine are not permitted.
- Use only detergents and additives that are suitable for use in domestic washing machines.
- The washing must not contain any inflammable solutions. Danger of explosion!
- Do not use the washing machine for dry cleaning.
- Dyes/colour removers may only be used in the washing machine, if the manufacturer of these products expressly permits this. We cannot be held responsible for any damage arising.

Child safety

- Keep packaging away from children. There is a risk of suffocation.
- Children often do not recognise the hazards associated with electrical appliances. Don't allow children to use the washing machine unsupervised.
- Make sure that children and pets don't climb into the drum of the washing machine. Could endanger life!

General safety

- Repairs to the washing machine must only be carried out by qualified service engineers.
- Never use the washing machine if the mains cable is damaged; or if the control panel, work top or plinth area is damaged such that the inside of the appliance is freely accessible.
- Switch off the washing machine before cleaning, maintenance and servicing. In addition, pull the mains plug out of the socket or – in the case of a permanent connection – switch off the cut-out in the fuse box or remove the screw fuse completely.
- If operation is stopped, disconnect the appliance from the mains supply and shut off the water tap.
- Never unplug the appliance by pulling on the cable. Always pull the plug.
- Multi-way plugs, connectors and extension cables must not be used. **This could constitute a fire hazard through overheating.**
- Never wash the washing machine down with a water jet. Danger of electric shock!
- In washing programmes with high temperatures the glass in the door gets hot. Do not touch it.
- Before emergency emptying of the appliance, before cleaning the drain pump or opening the door in an emergency, let the water cool down.
- Small animals can nibble at the cables and water hoses. Danger of electric shock and danger of water damage! Keep small animals away from the washing machine.



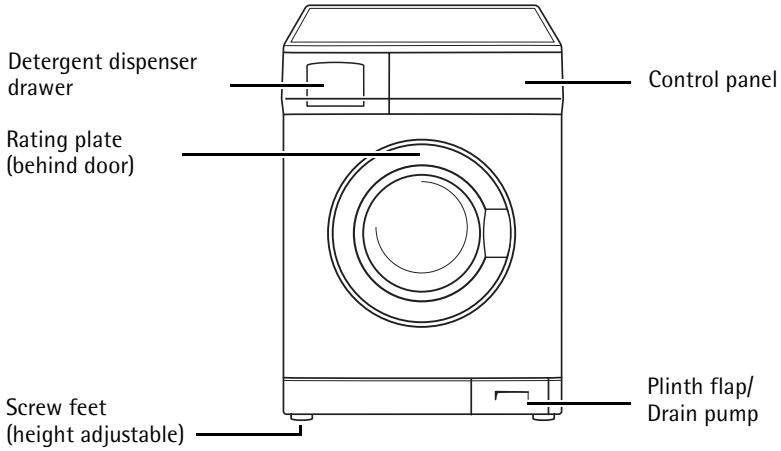



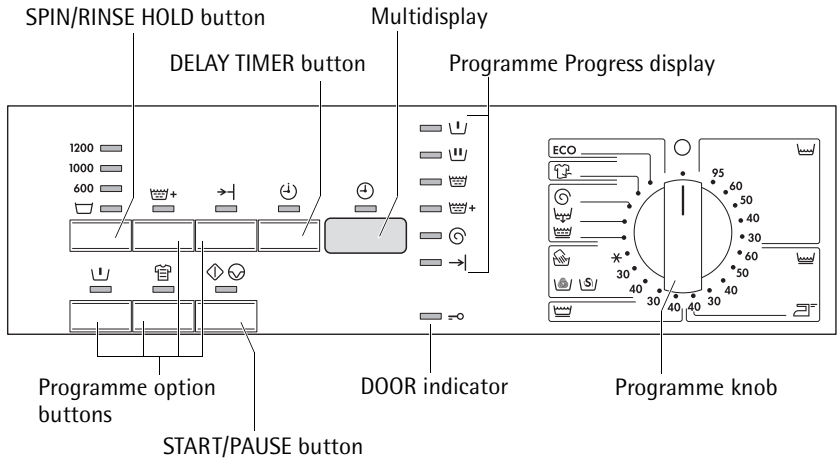









Description of the appliance



Control panel



Programme overview











Programme	max. load ¹⁾ (dry washing)	Programme options				Spin speed		
		 + (EXTRA RINSE)	 (QUICK WASH)	 (PRE WASH)	 (STAIN)	1200	1000/600	 (RINSE HOLD)
ECO (ENERGY SAVING) ²⁾	6 kg	•		•	•	•	•	•
 (COTTONS/LINEN) 95, 60, 50, 40, 30	6 kg	•	• ³⁾	•	• ⁴⁾	•	•	•
 (EASY-CARES) 60, 50, 40, 30	3 kg	•	•	•	• ⁴⁾		•	•
 (EASY IRON) 40	1 kg	•	•	•	•		•	•
 (DELICATES) 40, 30	3 kg	•	•	•			•	•
 /  (WOOL/SILK)  (HANDWASH) 40, 30, * (COLD)	2 kg						•	•
 (GENTLE RINSE)	3 kg						•	•
 (DRAIN)								
 (SPIN)	6 kg					•	•	
 (REFRESH)	3 kg						•	•

1) A 10 litre bucket contains approx. 2.5 kg of dry washing (cotton)

2) Programme settings for tests in accordance with or support of EN 60 456 and IEC 60 456 are described in the section "Consumption values".



3) Recommended load for short programmes is 3 kg; full loading is possible however with somewhat reduced cleaning results.

4)  (STAIN) can only be selected with wash temperatures of 40°C and above, as stain treatment products are only effective at higher temperatures.

Application/features:	Care symbols ¹⁾
Energy-saving programme at 60 °C for lightly to normally soiled whites/coloureds made of cotton/linen.	
Programme for normally to heavily soiled whites/coloureds made of cotton/linen.	
Programme for easy-care mixed fibres and synthetics.	
Special programme which washes at 40 °C for easy-care fabrics which after being washed using this programme need to be ironed only lightly or not at all.	
Gentle programme for delicate fabrics such as bonded fabrics, microfibres, synthetics, net curtains (max. load for net curtains 20 to 25 m ²). With  (RINSE HOLD) also suitable for fabrics with climate membrane, e.g., outdoor clothing.	
Particularly delicate programme for machine washable and hand washable wool/silk.	
Separate gentle rinse cycle (3 rinses, liquid conditioner is washed in from compartment  , gentle spin).	
Drains water away after a rinse hold.	
Drains water out and spins, e.g. after a rinse hold, or separate spin for hand-washed cottons/linens.	
Special programme at 30 °C, approx. 30 minutes long, for quickly washing through items such as e.g. slightly dirty sports clothing that have been worn once or new clothes.	

1) The figures in the care symbols indicate the maximum temperatures.

Before the first wash

1. Open the detergent drawer.
2. Pour approx. 1 litre of water through the detergent drawer into the washing machine.
This closes the water container when the next programme is started and the economy valve can function properly.
3. In order to remove any residues from the drum and water container which may have been left during manufacturing, perform the first wash cycle without any washing in the machine. Programme:  (COTTONS/LINEN) 60, press  (QUICK WASH), add approx. 1/4 measuring cup of washing powder.

Preparing and sorting washing

Preparing washing

- Empty pockets. Remove foreign bodies (e. g. coins, paper clips, nails, etc.).
- Do up zips, button up covers to prevent damage to washing.
- Remove the runners from net curtains or cover them with a net or a bag.
- Wash sensitive and small items in a net or a pillow case, e.g. net curtains, tights, socks, handkerchiefs, bras.

Important! Bras and other items containing wires should only be washed in a net bag. The wires can work loose and damage the appliance.

Sorting washing

- By colour: Wash white and coloured washing separately. Washing can run.
- By temperature, type of washing and care symbol.

Important! Do not wash fabrics with care symbol  (= do not wash!) in the washing machine.

Running a washing cycle

Opening the door/Loading the washing

1. To open the door: gently pull the handle on the door.

When the machine is switched on, the lights $\Rightarrow \bigcirc$ (DOOR) and \diamond / \bigcirc (START/PAUSE) indicate whether the door can be opened:

$\Rightarrow \bigcirc$ light (DOOR)	\diamond / \bigcirc light (START/PAUSE)	Can the door be opened?
lit green	flashes red or is off	yes
lit green	lit red	yes, after pressing the \diamond / \bigcirc (START/PAUSE) button
lit red or is off	flashes red or lit red	no, water level too high or temperature too high

2. Unfold washing and load it loosely into the machine. Mix large and small items.

Important: Do not get any washing caught between the door and the rubber seal.

3. Press the door firmly shut. Door catch must audibly latch.

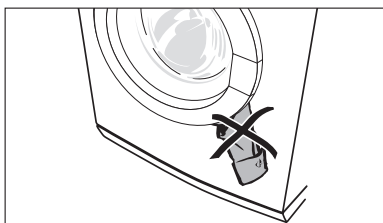

Adding detergent/additives

Important: Use only detergents and additives that are suitable for use in domestic washing machines.

Dose detergent and additives according to the instructions of the detergent and additive manufacturers. Follow the instructions on the packaging.

Dosing depends upon:

- the washing's degree of soiling,
 - the size of the load
 - the degree of hardness of the water supply.
- If the manufacturer does not give instructions for small loads: for a half load, use a third less, for a very small load, use only half of the detergent that is recommended for a full load.
 - From water hardness 2 (= medium) upwards, water softener should be used. Detergent can then always be dosed for water hardness 1 (= soft). Your local water company will be able to give you information about the water hardness in your area.

1. Pull the detergent dispenser drawer out as far as the stop.
2. Add the detergent/additives.
3. Push the drawer in fully.

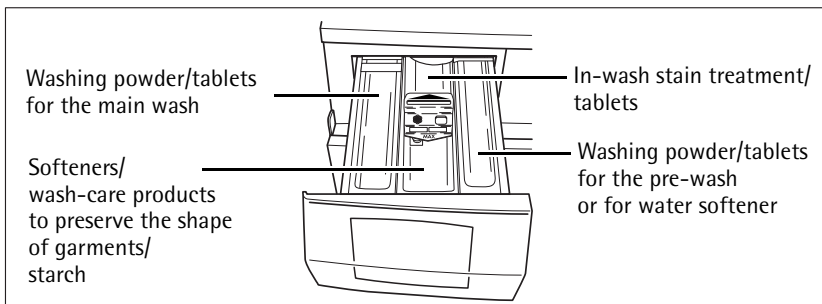

Washing powder/tablets for the main wash

If you are using water softener and need the right-hand compartment for the pre-wash detergent, add the water softener to the main wash detergent in the left-hand compartment.

Softeners, wash-care products to preserve the shape of garments, starch

Do not fill the compartment beyond the MAX mark. Dilute thick liquid concentrates according to the manufacturer's instructions before putting them into the drawer. Dissolve powder starches.

If you use liquid detergents:

Add liquid detergent using the dosage container provided by the detergent manufacturer.

Switching on the appliance/selecting a programme

Set the programme and temperature using the programme knob.



By selecting a programme, you switch the appliance on at the same time.

- The programme progress display indicates the programme steps that the selected programme will perform.
- In the multi-display the estimated length of the programme (in minutes) appears.

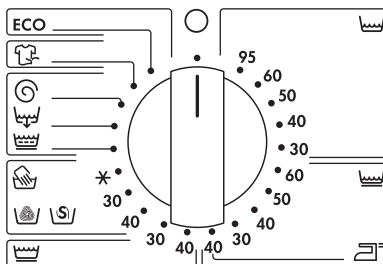



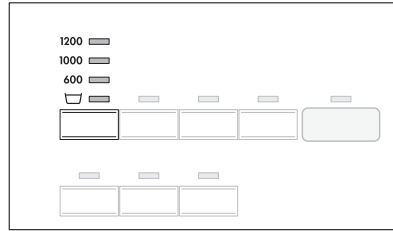

Changing the spin speed/Selecting rinse hold

The washing machine suggests the maximum permitted speed that is suitable for the selected programme. You can reduce this speed:

Press the SPIN/ (RINSE HOLD) button repeatedly, until the desired indicator lights up.



i The speed for the final spin can still be altered during the programme. To do this:

1. Press the / button (START/PAUSE).
2. Change the speed.
3. Press the / button (START/PAUSE) again.

(RINSE HOLD)

With  (RINSE HOLD) the washing is left to soak in the final rinse water. There is no final spin after the intermediate spin(s). Intermediate spins are programme-dependent and cannot be altered.



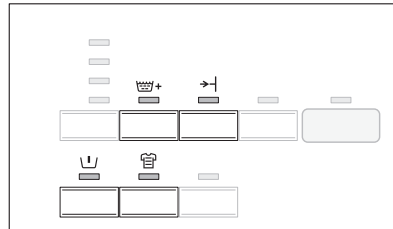

Selecting the programme options

If desired, press the programme option button(s). The corresponding indicator lights up.

i If "Err" is flashing in the multi-display, the programme option selected cannot be combined with the wash programme set.





+ EXTRA RINSE

With the programmes ECO (ENERGY SAVING),  (COTTONS/LINEN),  (DELICATES),  (EASY-CARES) and  (EASY IRON) two additional rinses are carried out (e. g. in cases of over-sensitive skin).

QUICK WASH

Shortened wash programme for less soiled items.







PREWASH

Hot pre-wash before the main wash that follows automatically; with intermediate spin for  (COTTONS/LINEN) and  (EASY-CARES), without intermediate spin for  (DELICATES).





STAIN

For heavily soiled or stained washing. In-wash stain treatments are washed in at the optimum time as the programme progresses. Can only be used for washing temperatures of above 40°C as stain removers are not effective at lower temperatures.







Setting the delay timer

-  Using the  button (DELAY TIMER) you can delay the start of a programme by 30 minutes (30') to a maximum of 23 hours (23h).
1. Select the programme.
 2. Press the  button (DELAY TIMER) repeatedly until the multi-display shows the desired time delay, e. g., 12h, if the programme is to start in 12 hours. The  indicator (DELAY TIMER) will light up.
-  If the display is showing 23h and you press the button again, the time delay will be cancelled. 0' will appear followed by the length of the wash programme that has been set.
3. To activate the delay timer, press the  button (START/PAUSE). The time remaining to the start of the programme is continuously displayed (e. g., 12h, 11h, 10h,... 30' etc.).

Starting a programme

1. Check that the tap is turned on.
 2. Press the  button (START/PAUSE). The programme is started or it starts after the time delay set has elapsed.
-  If after pressing the  button (START/PAUSE) E40 flashes in the multi-display, the →| (END) indicator flashes 4x and at the same time an acoustic signal sounds 4x, the door has not been correctly shut. Push the door firmly closed and press the  button (START/PAUSE) again.



Programme progress

- The programme progress display shows the programme step that is currently being carried out.
 -  (Prewash)
 -  (Main wash)
 -  (Rinse)
 - + (Extra Rinse)
 -  (Spin)
 -  (End)
- The multi-display shows the estimated time remaining (in hours and minutes) until the end of the programme.

i The remaining programme time may increase or briefly remain constant during the wash programme as the programme adjusts to various conditions while washing (e. g. type of washing, amount of washing, recognising out-of-balance when spinning, special rinse cycle, etc.).



Interrupting a programme/Adding washing

Interrupting a programme



- A washing programme can be interrupted at any time by pressing the  button (START/PAUSE) and then re-started by pressing the  button (START/PAUSE) again.
- To stop the washing machine before the programme has ended, turn the programme knob to  (OFF). **Important:** Be careful if there is water in the appliance!

Adding washing

It is possible to add washing, as long as the  (DOOR) light is lit green.

1. Press the  button (START/PAUSE). The door can be opened.
2. Close the door and press the  button (START/PAUSE) again. The programme will continue.

End of the wash cycle/Removing the washing

When the programme has finished,  (END) will illuminate on the programme progress display. The door can be opened as soon as the  indicator (DOOR) is lit green.





1. Open the door and remove the washing.
2. Turn the programme knob to  (OFF).
3. Close the water tap.

4. When you have finished washing, pull out the detergent drawer a little to let it to dry out. Keep the door very slightly open so that the washing machine can air.

If  (RINSE HOLD) has been selected:

Following a rinse hold →| (END) will be lit on the programme progress display.

The water must first be drained off:

- Either turn the programme knob to ○ (OFF), then to  (DRAIN) and press the  button (START/PAUSE) (the water will be drained without spinning),
- turn the programme knob to ○ (OFF) and then to  (SPIN). Change the spin speed, if necessary, and press the  button (START/PAUSE) (the water will be drained and the washing spun).

Child safety device

When the child safety device is set, the door can no longer be closed.

Setting the child safety device:

Use a coin to turn the knob (on the inside of the door) in a clockwise direction as far as it will go.

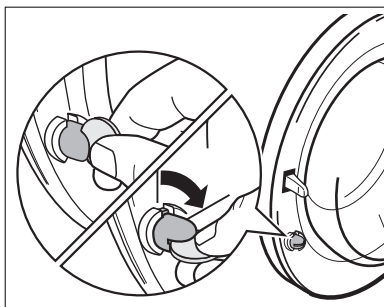

Warning! The knob must not be sunk-in after being set, otherwise the child safety device is not active. The knob must stand proud as shown in the illustration.

Releasing the child safety device:

Turn the knob anti-clockwise as far as it will go.

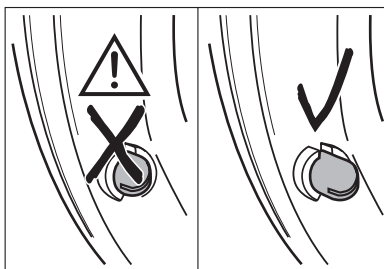

Cleaning and maintenance

Important! Do not use furniture care products or aggressive cleaners to clean the appliance.

Wipe control panel and body with a damp cloth.

Detergent dispenser drawer

The detergent dispenser drawer should be cleaned regularly.

1. Remove the detergent dispenser drawer by pulling it firmly.
2. Remove the conditioner insert from the middle compartment.
3. Clean all parts with water.
4. Put the conditioner insert in as far as it will go, so that it is firmly in place.

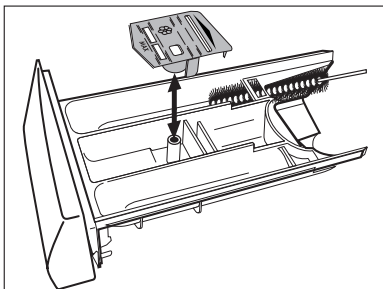

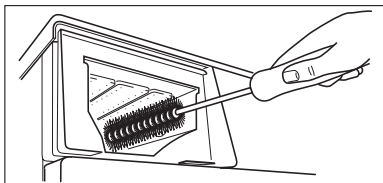

5. Clean all parts of the washing machine, especially the nozzles in the top of the washing-in chamber, with a brush.
6. Insert the detergent dispenser drawer in the guide rails and push it in.



Washing drum

Rust deposits in the drum may occur due to rusting foreign bodies in the washing or tap water containing iron.

Important! Do not clean the drum with acidic descaling agents, scouring agents containing chlorine or iron or steel wool.

1. Remove any rust deposits on the drum with a cleaning agent for stainless steel.
2. Run a washing cycle without any washing to clean off any cleaning agent residues. Programme:  (COTTONS/LINEN) 60, press the button  (QUICK WASH), add approx. 1/4 measuring cup of washing powder.

Door and rubber collar

Regularly check whether deposits or foreign bodies are present in the folds of the rubber collar or on the inside of the glass door.

Clean the glass in the door and the rubber collar regularly.

What to do if...

Remedying small malfunctions

If during use of the appliance one of the following error codes is shown in the multi-display:



- **E iG** (Problems with water inflow),
- **E2G** (Problems with water outflow),
- **E4G** (door open),

please have a look at the following table.

When the fault is remedied, press the  button (START/PAUSE).

In the event of other errors (**E** and a number or letter): Switch the appliance off and then on again. Re-set the programme. Press the  button (START/PAUSE).

If the error appears again, please contact the Customer Care Department, stating the error code.

Problem	Possible cause	Remedy
Washing machine is not working.	Mains plug not plugged in or fuse not working.	Connect the plug to a mains socket. Check fuse.
	Door not closed properly.	Close door - there should be an audible click.
	The  button (START/PAUSE) button was not pressed for long enough.	Press the  button (START/PAUSE).
The door cannot be closed.	Child safety device engaged.	Release the child safety device.
When a button is pressed, Err appears in the multi-display.	The selected function cannot be combined with the programme set.	Select another function.
E4G appears. → indicator (END) flashes 4x, at the same time an acoustic signal sounds 4x.	The door is not closed properly.	Close the door properly. Re-start the programme.
E iG appears. → indicator (END) flashes 1x, at the same time an acoustic signal sounds 1x. (Problems with water inflow)	Tap turned off.	Turn on the tap.
	The filter in the threaded inlet hose fitting is blocked.	Turn off the tap. Unscrew the hose, take out the filter and clean it.
	Water tap is furred with lime scale or is faulty.	Check the tap and have it repaired, if necessary.

Problem	Possible cause	Remedy
The washing machine vibrates when operating or is not stable.	The transit bar has not been removed.	Remove the transit bar.
	The screw feet are not correctly adjusted.	Adjust the feet as described in the installation and connection instructions.
	There is very little washing in the drum (e.g., just one bathrobe).	Operation is not affected by this.
Water is running out from under the washing machine.	Screw connection on the inlet hose is leaking.	Screw the inlet hose on tightly.
	Drain hose is leaking.	Replace drain hose.
	Drain pump cover is not closed properly.	Close the cover properly.
	Washing was caught in the door.	Load washing carefully for the next wash.
	Emergency drain hose is leaking.	Close off emergency drain hose properly.
Washing water is foaming excessively. At the end of the washing cycle, the spin stops.	Probably too much detergent has been used.	Follow the manufacturer's instructions exactly when measuring out detergent.
E20 appears. → indicator (END) flashes 2x, at the same time an acoustic signal sounds 2x. (Problems with water outflow)	Kink in drain hose.	Straighten the hose.
	Maximum pumping height of 1 m exceeded.	Please contact the Customer Care Department.
	Drain pump is blocked.	Switch off the appliance. Disconnect the power plug. Clean the drain pump. Remove foreign bodies from the pump housing.
	For sink spigot connections: The sink spigot is blocked.	Clean the sink spigot.
Conditioner not rinsed in,  compartment for additives is filled with water.	Conditioner insert in the compartment for additives is not correctly attached or is blocked.	Clean the detergent drawer, insert the conditioner insert firmly.

Problem	Possible cause	Remedy
The door cannot be opened when the washing machine is switched on.	Door locked.	Wait until \rightarrow indicator (DOOR) is lit green.
	There has been a power cut. (All indicators are off.) For safety reasons, the door remains locked for approx. 4 to 10 minutes.	The programme will continue when the power cut is over. To remove washing: If water can be seen in the appliance, before opening the door, first drain off the water. (See section "Carrying out an emergency drain".)
Washing is heavily creased.	Possibly too much washing was loaded.	Observe maximum loads.

If the wash results are not satisfactory

Washing is grey and scale is being deposited in the drum

- Too little detergent is being used.
- The right detergent was not used.
- Special soiling was not pre-treated.
- Programme or temperature was not correctly set.

There are grey stains on the washing.

- Washing soiled with ointment, grease or oil was washed with too little detergent.
- It was washed at too low a temperature.
- A common cause is that fabric conditioner – especially a concentrate – has got onto the washing. Such stains should be washed out as quickly as possible and make sure that you are careful when using fabric conditioner.

After the last rinse foam can still be seen.

- Modern detergents may create foam even in the last rinse cycle. The washing is however sufficiently rinsed.

There are white residues on the washing.

- This is due to the insoluble ingredients in modern detergents. They are not caused by insufficient rinsing. Shake or brush the washing. If possible turn the washing inside out before washing. Check your choice of detergent. Especially with dark colours it is advisable to use liquid detergents.

Carrying out an emergency drain



Warning! Before emergency draining, switch off the washing machine and remove the mains plug from the socket.

Warning! The water that comes out of the emergency drain hose may be hot. There is a risk of scalding. Let the water cool before performing an emergency drain.

1. Open the plinth flap and remove it.

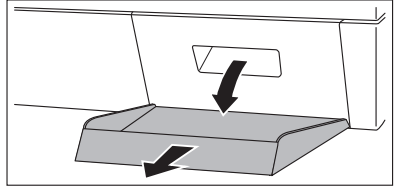

2. Take out the emergency drain hose.

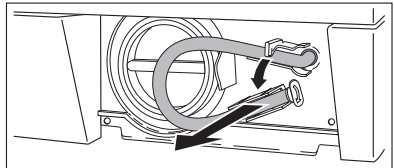

3. Place a shallow container underneath it. Then loosen the drain plug by turning it in an anti-clockwise direction and pull it out.

4. The water runs out. If it is necessary to empty the container more than once, seal up the emergency drain hose with the drain plug while you are doing so.

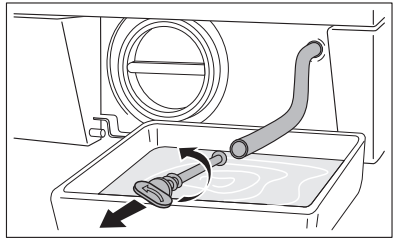

When the water has all drained away:

5. Push the drain plug firmly into the emergency drain hose and screw it tight in a clockwise direction.
6. Place the emergency drain hose back in the support.
7. Insert the plinth flap and close it.

Drain pump

The drain pump is maintenance-free. It is only necessary to open the pump cover if there is a malfunction and water is no longer being pumped out, e. g. if the pump wheel is blocked.

Please make sure before loading the washing that there are no foreign bodies in the pockets or caught between the washing. Paperclips, nails, etc. that may have got into the washing machine with the washing remain in the pump housing (foreign body trap that protects the pump wheel).



Warning! Before opening the pump cover, switch off the washing machine and remove the mains plug from the socket.

1. First carry out an emergency drain.
2. Place a cloth on the floor in front of the drain pump cover. Residual water runs out.
3. Unscrew the pump cover in an anti-clockwise direction and remove it.

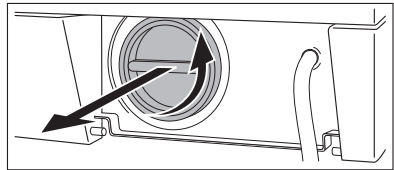

4. Remove foreign bodies and fluff from the pump housing and from the pump wheel.

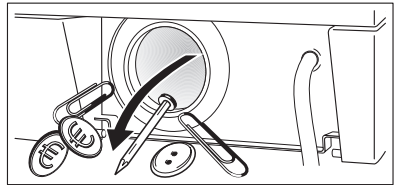

5. Check whether the pump wheel right at the back of the pump housing can turn. (It is normal for the pumping wheel to turn jerkily.) If the pumping wheel cannot be turned, please contact the Customer Care Department.

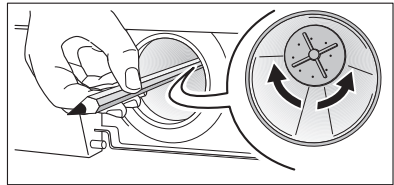

6. Insert the pump cover. Insert the guides at the sides of the cover into the guide slots and tighten the cover by turning in a clockwise direction.

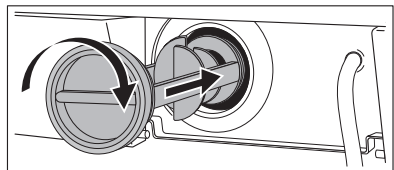

7. Close off the emergency drain hose and place it in the support.
8. Close plinth flap.

Disposal



Packaging material

The packaging materials are environmentally friendly and can be recycled. The plastic components are identified by markings, e.g. >PE<, >PS<, etc. Please dispose of the packaging materials in the appropriate container at the community waste disposal facilities.



Old appliance

The symbol  on the product or on its packaging indicates that this product may not be treated as household waste. Instead it shall be handed over to the applicable collection point for the recycling of electrical and electronic equipment. By ensuring this product is disposed of correctly, you will help prevent potential negative consequences for the environment and human health, which could otherwise be caused by inappropriate waste handling of this product. For more detailed information about recycling of this product, please contact your local city office, your household waste disposal service or the shop where you purchased the product.



Warning! When an appliance is finished with, remove the plug from the mains socket. Cut off the cable and plug and dispose of them. Destroy the door lock. This prevents children from trapping themselves inside and endangering their lives.





Technical data

- CE** This appliance conforms with the following EU Directives:
- 73/23/EEC dated 19.02.1973 Low Voltage Directive
 - 89/336/EEC dated 03.05.1989 EMC Directive inclusive of Amending Directive 92/31/EEC
 - 93/68/EEC dated 22.07.1993 CE Marking Directive

Height x Width x Depth	850 x 598 x 603 mm
Depth when door is open	980 mm
Height adjustment	approx. +10/-5 mm
Load (depending on programme)	Max. 6kg
Area of use	Domestic
Drum spin speed	see Rating Plate
Water pressure	1-10bar (=10-100N/cm ² =0.1-1.0MPa)

Consumption values

The consumption values were obtained under standardised conditions. They may vary when operating in domestic conditions.

Programme selector Temperature	Load size in kg ¹⁾	Water in litres	Energy in kWh
 (COTTONS/LINEN) 95	6	62	2,20
ECO (ENERGY SAVING) ²⁾	6	49	1,02
 (COTTONS/LINEN) 40	6	58	0,70
 (EASY-CARES) 40	3	58	0,52
 (DELICATES) 30	3	58	0,42
 (WOOL/SILK/HANDWASH) 30	2	54	0,35

1) The load size is determined in accordance with the EN 60456 standard load.

2) **Note:** Programme setting for testing in accordance with or in support of Standard EN 60 456 and IEC 60 456. Consumption values will vary from those quoted depending on the pressure and hardness of the water and its initial temperature, the room temperature, type and quantity of washing, detergent used, fluctuations in mains voltage and options selected.

Installation and connection instructions



Safety information for the installation

- This washing machine **cannot be built-in**.
- Before using for the first time, check the appliance for damage sustained while it was being transported. Do not under any circumstances connect an appliance that is damaged. In the case of damage, please contact your supplier.
- Before using for the first time, all parts of the transit packaging must be removed. Otherwise when spinning damage may be caused to the appliance or to neighbouring units or furniture.
- Before using the appliance for the first time, splash protection must be completed. (See "Removing the transit packaging".)
- Always plug the mains plug into a correctly installed shockproof socket.
- Permanent connection: a permanent connection must only be installed by a trained electrician.
- Prior to using the appliance for the first time, ensure that the rated voltage and type of supply on the rating plate match that of the supply where the appliance is to be installed. The fuse rating is also to be found on the rating plate.
- If work on the plumbing is required for the proper connection of the washing machine to the water supply, this must be undertaken by a registered plumber.
- If work on the electricity supply system is required for the proper connection of the washing machine to the electricity supply, this must be undertaken by a registered electrician.
- The washing machine's cable must only be replaced by the Customer Care Department or a registered electrician.

Installing the appliance

Transporting the appliance



Warning! The washing machine is very heavy. Risk of injury. Be careful when lifting.

- Do not lay the appliance on its front nor on its right side (as seen from the front). Electrical components may get wet.
- Never transport the appliance without its transit packaging. Only remove the transit packaging when the appliance is in its place of installation. Transporting the appliance without its transit packaging can lead to damage to the appliance.
- Never lift the appliance by the door when it is open nor by the plinth.

When moving using a sack trolley:

- Only use the sack trolley on the side of the appliance.

Removing the transit packaging

Important! Before using the appliance for the first time, all parts of the transit packaging must be removed! Keep the transit packaging in a safe place, in case it is needed at a later date when the appliance is to be moved (e.g. moving house).

1. At the back of the appliance, open both hose clips and remove both hoses and mains cable.
2. Remove both hose clips from the appliance by jerking them hard.

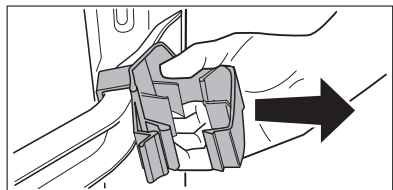
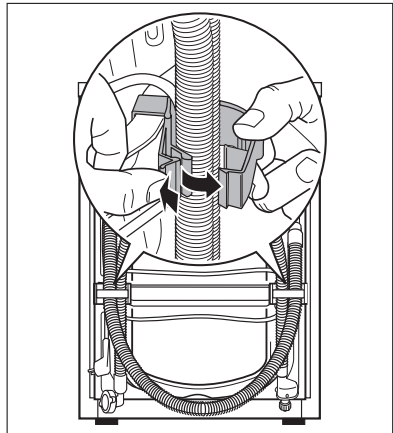

3. Remove both plastic caps sideways.

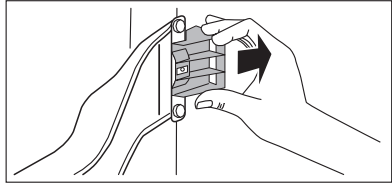

i Special spanner A and sealing caps B (2 off) and C (1 off) are supplied with the appliance.

4. Remove screw D with its compression spring using special spanner A.

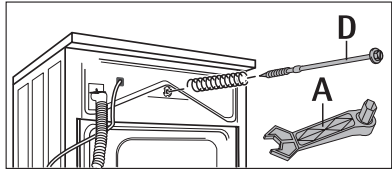

5. Turn sealing cap C upside down as shown in the illustration.

6. Seal hole using sealing cap C.

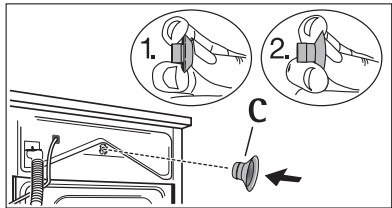

7. Unscrew and remove two screws E using special spanner A.

8. Unscrew and remove four screws F using special spanner A.

9. Remove transit bar G.

10. Screw in the four screws F again.

11. Seal the two big holes using sealing caps B.

Important! Press all sealing caps B (2 off) and C (1 off) in firmly, so that they snap into place. (Splash protection).

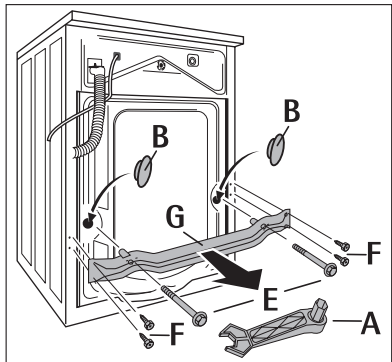

Where to install

Important! The appliance must not be used in a room where there is a danger of frost. Frost damage or impaired operation! Frost damage is not covered by the warranty.

- The surface on which the appliance is to be installed must be firm and level. Do not install the appliance on carpets or on soft floor coverings.

- The surface on which the appliance is to be installed must be clean and dry and free from coverings that move, so that the appliance does not slide.
- If the location in which the appliance is to be installed is fitted with small-format tiles, put a rubber mat (available in the shops) under the appliance.

If the appliance is to stand on a plinth:

In order for the appliance to be secure on the plinth, fixing plates*) must be mounted, into which the appliance is inserted.

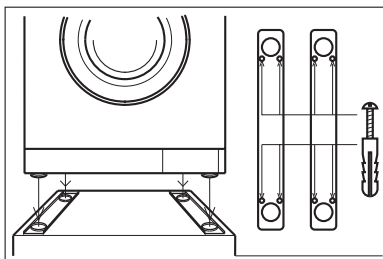

If the appliance is to stand on floors that vibrate, e. g. floors of wooden joists with deal boards:

If possible, install the appliance in one corner of the room.

1. Screw a water-resistant wooden board (at least 15 mm thick) onto at least 2 of the floor joists.
2. Affix fixing plates *) onto the wooden board, into which the appliance is inserted.

*) The fixing plates can be obtained from the Customer Care Department.

Making the appliance level

The four feet of the appliance are pre-adjusted.

Large degrees of unevenness can be compensated for by individually adjusting the height adjustable screw feet.

Use the special spanner supplied to do this.

Important! Do not use pieces of wood, cardboard or such like to level out unevenness in the floor, but adjust the height adjustable screw feet instead.

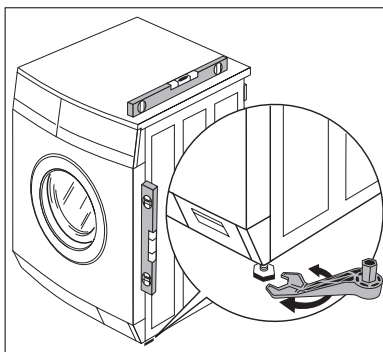

Electrical connection

Details about the voltage, type of supply and the fuses required are to be found on the rating plate. The rating plate is next to the doorway.

Connecting to the water supply

Important!

- This appliance **must not** be connected to the hot water system.
- When connecting it, use only new hose kits.
- Only connect the appliance to the drinking water supply. Rain water or water for industrial use may only be used if it fulfils the requirements of DIN 1986 and DIN 1988.
- Do not kink or crush the water inlet hose or drain hose.

Permitted water pressure

The water pressure must be at least 1 bar ($= 10\text{N/cm}^2 = 0.1\text{MPa}$) and may be a maximum of 10bar ($= 100\text{N/cm}^2 = 1\text{MPa}$).

- If more than 10bar: Connect a pressure reduction valve.
- If less than 1 bar: Disconnect the appliance end of the inlet hose from the solenoid inlet valve and remove the flow meter. (In addition remove the filter using pointed pliers and take out the rubber gasket behind it.) Re-insert the filter.

Water inflow

A 1.50 m long pressure hose is supplied with the appliance.
If a longer water inlet hose is required, only original hoses are to be used. The Customer Care Department stocks hose kits of different lengths.



Sealing rings are either inserted in the plastic nuts of the threaded hose fitting or are included as spare parts. Do not use any other seals.

Important! All threaded hose fittings must only be tightened by hand.

1. Connect the hose with the right-angle connector to the machine.

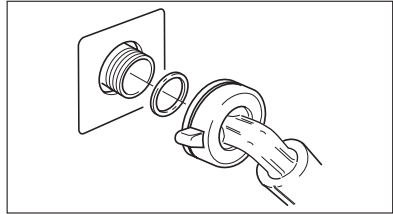

Important! Do not position the inlet hose vertically downwards. Position it to the right or the left as shown in the illustration.

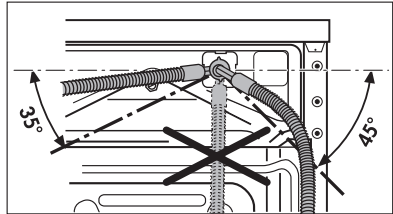

2. Connect the hose with the straight connector to a water tap with an R $\frac{3}{4}$ (inch) screw thread.
3. Open the water tap slowly and check all connections for water tightness.

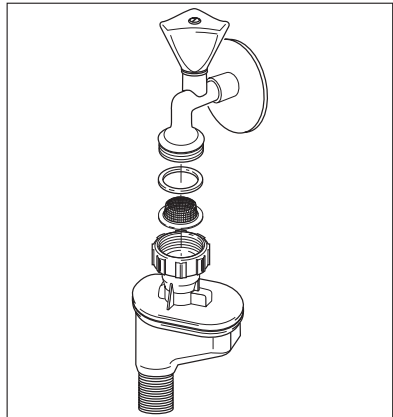

Water drainage

The maximum permitted difference between the height of the surface on which the appliance is installed and the water outlet is 1 metre. Only original hoses may be used to extend hoses. (A maximum of 3 m laid on the floor and then 80 cm vertically). The Customer Care Department stocks outlet hoses of different lengths.

Draining water into a sink outlet

Secure the outlet/sink outlet joint with a hose band clip (available from your dealer).

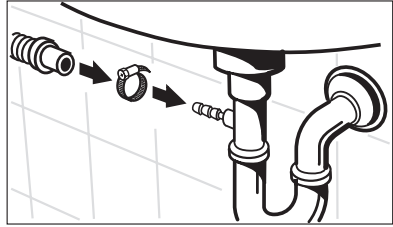

Draining water into a wash basin/bath



Important!

- Small basins are not suitable. Water may overflow.
- The end of the drain hose must not be in the water that has been pumped out. Otherwise water could be sucked back into the appliance.
- When draining into a wash basin or a bath, secure the drain hose with the supplied elbow to stop it slipping. Otherwise the water running out can force the hose out of the basin.
- When pumping the water out, check that the water is running away fast enough.

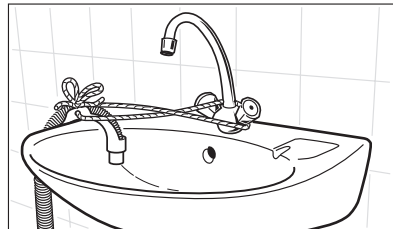
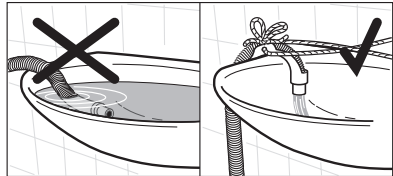

Pumping heights over 1 m

The washing machine's drain pump is able to pump water to a height of 1 meter, calculated from the surface on which the appliance is installed.

Warning! If pumping height is over 1 metre, malfunctions and damage to the appliance may arise.

For pumping heights over 1 metre a conversion kit can be obtained. Please contact the Customer Care Department.

Guarantee/Customer Service

Weitere Kundendienststellen im Ausland

In diesen Ländern gelten die Garantiebedingungen der örtlichen Partner. Diese können dort eingesehen werden.

Further after-sales service agencies overseas

In these countries our AEG-Electrolux agents' own guarantee conditions are applicable. Please obtain further details direct.

Autres agences étrangères assurant le service après-vente

Dans ces pays, les conditions de garantie des concessionnaires de la région sont valables. Vous pouvez les consulter sur place.

Otros puntos de Postventa en el extranjero

En estos países rigen las condiciones de nuestros representantes locales, las cuales pueden ser consultadas allí mismo.

Ulteriori uffici del servizio tecnico assistenza clienti all'estero

In questi paesi sono valide le condizioni di garanzia dei partner locali. Queste condizioni possono essere esaminate sul luogo.

Serviços de assistência técnica no estrangeiro

Nestes países são válidas as condições de garantia dos concessionários locais, podendo aí ser consultadas.

További vevőszolgálati irodák külföldön

Ezekben az országokban a mi AEG-Electrolux vevőszolgálatainknál saját jótállási feltételek alkalmazhatók. A további adatokat kérjük közvetlenül szerezzék be.

Servisne službe

Na garancijskem listu boste našli seznam pooblaščenih servisnih služb AEG-Electrolux.

U.A.E. Abu Dhabi Universal Trading Company P.O. Box 43 99 Tel.: 6335331 Service Center 6733974	Jordan Jordan Household Supply Co. Ltd. P.O. Box 3/68 Amman/Tel.: 69 70 50	Malta ITC International Trading Company White House Building Mountbatte Street Blata L-Bajda/Tel.: 220644
Egypt Middle East Commercial Center 4 Salah El Dein St. - 2nd floor Heliopolis, Kairo Egypt Tel.: 2024181719	Canada EURO-LINE Appliances 2150 Winston PARK Drive 20 Oakville, Ontario L6H 5V1 Tel.: 905 829 3980 Fax: 905 829 3985	Mauritius Happy World Centre Ltd. P.O. 7 54 1 Chausee Street Port Louis Tel.: 25355

<p>Australia The Andi-Co Group 1 Stamford Road Oakleigh VIC 3166 Tel.: (03) 9569 1255 Fax: (03) 9569 1450 www.andico.com.au</p>	<p>Korea (South) Core Incorp. 3/F Chewoo Bldg. 200 Nonhyun-Dong Kangnam-Ku 135-010 Seoul Telefon 82 2 549 89 61</p>	<p>Namibia AEG NAMIBIA (PTY) LIMITED-Jeppe Street Northern Industrial Area Windhoek Tel.: (061) 21-6082/4 Fax: (061) 217838</p>
<p>Bahrain/Arabian Gulf A.A. Zayani & Sons P.O. Box 9 32 Bahrain Tel.: 17311124</p>	<p>Croatia Electrolux D.O.O. Suplova 7 10000 Zagreb Tel.: 1 61 19512 Fax: 1 61 19513</p>	<p>New Zealand Monaco Corporation Ltd. 10 Rothwell Avenue Albany - Auckland 4399 Auckland 1 New Zealand Tel.: 00 64-92 59 11 11 Fax: 00 64-92 59 11 12</p>
<p>Bulgaria Electrolux Bulgaria E.O.O.D. 91 Levski Blvd. 1000 Sofia Tel.: 2 806676 Fax: 2 980 5276</p>	<p>Kuwait/Arabian Gulf Ali Al-Ghanim Est. P.O. Box 21540 - Safat Tel.: 4822190 Fax: 4820116</p>	<p>Syria WATAR CO. P.O. Box 36109 Mazzeh - Damascus Direct Phone: 00963116132649 Fax: 00963116119537</p>
<p>Cyprus Hadjikyrlakos & Sons Ltd. Prodromou 121 P.O. Box 21587 Nicosia 1511 Service Telephones: Nicosia 02 481226 Limassol 05 562182 Larnaca 04 633929 Paphos 06 932 699</p>	<p>Lebanon Adib & Assaferi P.O. Box 539 Tripoli</p>	<p>Iran ARIAN International Development Co. AEG Showroom Shariati, Balatar as Safar Teheran / Iran Phone No. Showroom: 021 / 285 513 / 4 Phone No. Service: 021 / 312 27 67 / 8</p>
<p>Estonia Electrolux Estonia Ltd. Mustamäe tee 24 EE0006 Tallinn Tel.: (372) 6 650 090 Fax: (372) 6 650 092</p>	<p>Latvia Electrolux Latvija Ltd. Kr.Barona iela 130/2 Riga, LV-1012 Tel.: 371 7313626 Fax: 371 7845954</p>	<p>Poland Electrolux Poland Sp. zo.o. ul. Domaniewska 41 02-034 Warszawa tel.: 022 874 33 33 fax: 022 874 33 00</p>
<p>Hong Kong Dah Chong Hong Ltd. 20 Kai Cheung Road Kowloon Bay Kowloon - Hong Kong Tel.: 0085222621620 Fax: 0085227550333</p>	<p>Lithuania Electrolux Lithuania Verkui 29 2600 Vilnius Tel.: 372 272 3326 Fax: 372 272 3366</p>	<p>Russia Electrolux Russia Ltd. 16 Olympiysky prospekt 129090 Moscow Tel.: (095) 937 7837 Fax: (095) 926 5513</p>
<p>Israel Evis Ltd. Tadiran-Ampa Service 10 Gibonay Israel Street New Industrial Zone Netanya, 42504 Israel</p>	<p>Malaysia Arzbergh Engineering No. 49A/B, Jalan Petaling Utama 7 4600 Petaling Jaya Tel.: 3 795 1084 Fax: 3 795 1082</p>	<p>Saudi Arabia Awad Badi Nahas Est Shara Sirteen Jeddah 21463 Phone: 6646583 Alia Trading Co Mecca Road Riyadh 11491 Phone 4645977</p>

<p>Japan Electrolux Japan Ltd. Domestic Appliances Department Maruzen Showa Warehouse Building Tookai 4-5-12, Ota-ku 143-006 Tokyo Tel.: 0120-13-7117 Fax: 03-3790-5257</p>	<p>Singapore Group Pte Ltd. 833 Bukit Timah Road Unit no. 01-11 Royalville 279887 Singapore Tel.: 0065 64638484 Fax: 0065 64638488</p>	<p>Slovenia Electrolux Slovenia D.O.O. Traska Ul. 132 1000 Ljubljana Tel.: 61 1234 137 Fax: 61 1234 238</p>
<p>Thailand Olympia Thai Tower, 444 Rachadapiser Road Samsennok- Huaykwang 10320 Bangkok Thailand Tel.: 006625136111 Fax: 006625136334</p>	<p>Slovakia Rep. Electrolux Slovakia S.R.O. Seberiniho 1 821 03 Bratislava Tel.: 02 4333 4322, 4355 Fax: 02 4333 6976</p>	<p>South Africa AEG (Pty) Ltd. 55, 12th Road P.O. Box 1 02 64 Kew/Johannesburg 2000 Tel.: 8069111</p>
<p>Hungary Electrolux Lehel KFT Erzsébet Királyné útja 87. 1142 Budapest Tel.: 00361/467-3200</p>		

Service

In the event of technical faults, please first check whether you can remedy the problem yourself with the help of the operating instructions (section "What to do if...").

If you were not able to remedy the problem yourself, please contact the Customer Care Department or one of our service partners.

In order to be able to assist you quickly, we require the following information:

- Model description
- Product number (PNC)
- Serial number (S No.)
(for numbers see rating plate)
- Type of fault
- Any error messages displayed by the appliance

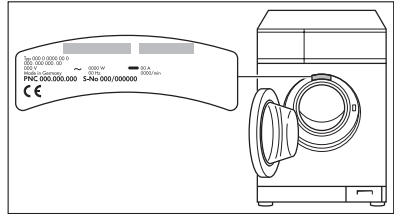

So that you have the necessary reference numbers from your appliance at hand, we recommend that you write them in here:

Model description:

PNC:

S No:

 **From the Electrolux Group. The world's No. 1 choice.**

The Electrolux Group is the world's largest producer of powered appliances for kitchen, cleaning and outdoor use. More than 55 million Electrolux Group products (such as refrigerators, cookers, washing machines, vacuum cleaners, chain saws and lawn mowers) are sold each year to a value of approx. USD 14 billion in more than 150 countries around the world.

AEG Hausgeräte GmbH
Postfach 1036
D-90327 Nürnberg

<http://www.aeg-electrolux.de>

© Copyright by AEG

105 176 712-00-040705-01

Subject to change without notice